

GOBBLER™ / BRACKET IDENTIFICATION

See PRICE SHEET for more information

PAGE 1 of 2

Please E-mail us at service@wrightmfg.com to help us keep up to date with Gobbler/mower compatibility issues.

**GG250
GGJ350**

Universal
Gobbler
(Requires bracket)

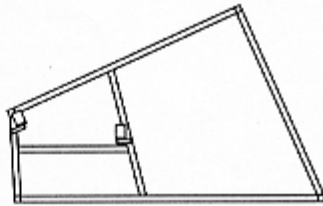

COMMON STYLE (EAR SPACING DIFFERS)

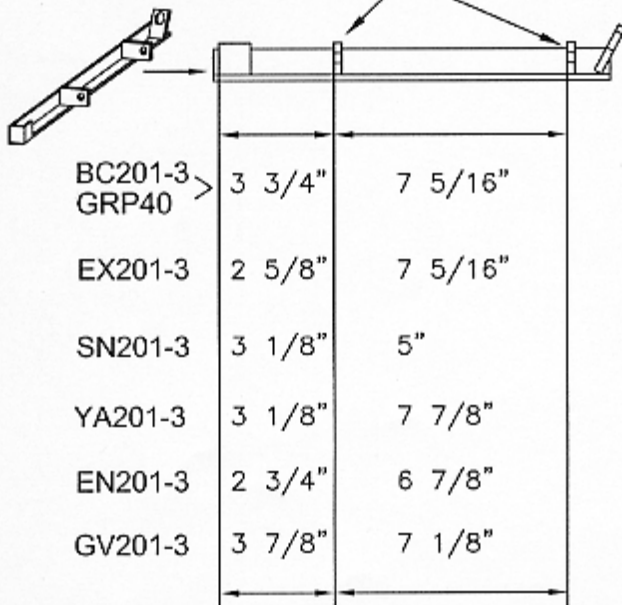

'95 - '00 BUNTONS with
10 3/4" hole spacing in deck

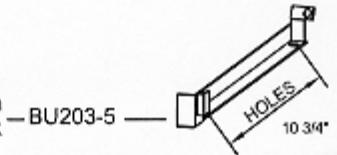

BYERS GOLD — BY201-3

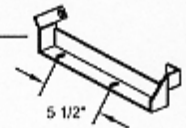

Designed for 48" Exmark & Toro
fixed decks but may fit others
with 9 1/2" mower tab spacing

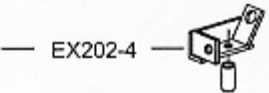

EXMARK 52" TURF TRACER — EX252



Pre '95 Buntions — BU202-4
Bobcats with chute deflector
tabs bent off of deck support

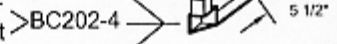

Pre '95 John Deere fabricated decks — JD202-4

Pre '96 Snapper Pro SKP202-4

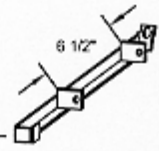

**GG450
GGJ550**

Universal
Gobbler (Patented)

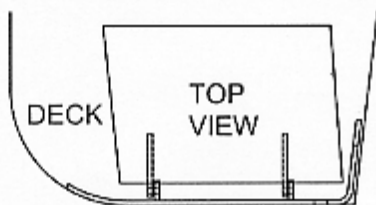

Originally designed to fit Exmark / Turf Tracers
but also fits most other exmark / decks and brands
that have a 1 1/2" flatbar deck support at the outer
edge of the deck and where
the mower opening is no
larger than about 5" x 13"

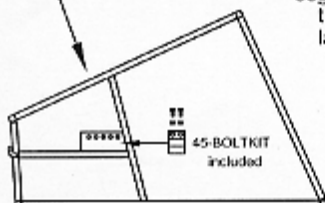

(will need to drill
one hole here — if
none already exists)

NO DECK BRACKET REQUIRED

LEAF GOBBLER™

Adds 4.6 cu. ft. to any
JUMBO or TURBO 4
GOBBLER

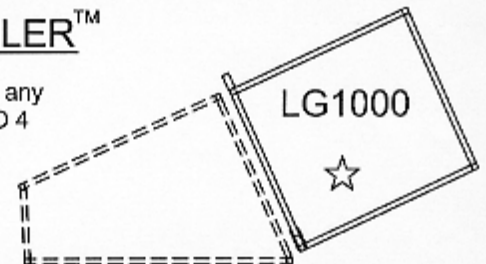

GOBBLER™ SIZES

